

**THE CORPORATION OF THE  
CITY OF WHITE ROCK  
BYLAW NO. 1923**



A Bylaw to Regulate the Placing, Maintenance  
and Repair of Signs

**DISCLAIMER: THIS BYLAW IS CONSOLIDATED FOR CONVENIENCE ONLY. THE CITY DOES NOT WARRANT THAT THE INFORMATION CONTAINED IN THIS CONSOLIDATION IS CURRENT. IT IS THE RESPONSIBILITY OF THE PERSON USING THIS CONSOLIDATION TO ENSURE THAT IT ACCURATELY REFLECTS CURRENT BYLAW PROVISIONS.**

Consolidated as of April, 2026

<b>TABLE OF CONSOLIDATION</b>			
<b>BYLAW</b>	<b>DATE APPROVED</b>	<b>AMENDMENT NO.</b>	<b>SUBJECT MATTER</b>
1963	April 16, 2012	#1	7. Item 6 Promotional Signs, Schedule II
2072	January 26, 2015	#2	Parts 2, 6, and 7 relating to Construction Project Signage, development project signage, and Changeable Copy or Electronic Message Board Signs.
2090	July 27, 2015	#3	Replacing Part 7 section 3.2 relating to fascia signs impacting buildings with more than one premise.
2380	October 25, 2021	#4	10. Political Signage Amendments
2449	December 5, 2022	#5	Part 6 Section 10. Political Signage Amendments – Sign guidelines
2452	January 16, 2023	#6	Amendment to Schedule II – Permit Fee Schedule
2478	October 16, 2023	#7	Part 4 – regarding Third Party Signs
2579	April 20, 2026	#8	Part 7 - amend the White Rock Sign Bylaw in relation to the interaction between "copy" "copy area" and other related definitions and fascia signs.

Under the statutory powers of the *Local Government Act* and the *Community Charter*, the Council of the Corporation of the City of White Rock, in open meeting assembled, enacts the following provisions:

## **PART 1 – INTRODUCTORY PROVISIONS**

### Title

1. This Bylaw shall be cited as the “White Rock Sign Bylaw, 2010, No. 1923.”

### Purpose

2. The purpose of this Bylaw is to:

- 2.1. Reflect the aesthetic standards and enhance the appearance and the unique identity of the City of White Rock;
- 2.2. Support the viability of local businesses by providing sufficient opportunity for them to advertise their places of business and the types of goods and services available on the premises;
- 2.3. Ensure that public safety and traffic safety are not compromised; and
- 2.4. Enable fair and consistent enforcement of sign regulations.

### Definitions

3. In this Bylaw:

**“Abandoned Sign”**

means any Sign which no longer serves its previously intended purpose, or which is not maintained as required by this Bylaw.

**“Animated Sign”**

means a Sign which includes action, motion or colour changes to any part of the Sign, but does not including an Electronic Message Board Sign or a time and temperature sign.

**“Awning”**

means a weather protection device made of non-rigid material, supported entirely by and extending from the exterior wall of a building by a fixed or retractable frame.

**“Awning Sign”**

means any Sign which is painted onto, stencilled on or attached to any surface on an awning and does not extend vertically or horizontally beyond the limits of the awning.

**“Balcony”**

means a floor projecting beyond an exterior wall of a building and includes any associated railing, balustrade or parapet.

**“Banner Sign”**

means a Temporary Sign composed of lightweight, non-rigid material such as cloth, canvas or similar fabric.

**“Bed and Breakfast Sign”**

means a Sign identifying an accessory use bed and breakfast establishment located on the premises.

**“Billboard”**

means any Sign with a Sign Area exceeding 3.0 square metres (32.29 square feet) and which contains third party advertising.

**“Building”**

means any structure wholly or partly enclosed by a roof or roofs, supported by walls, columns or posts and used or intended for the shelter or accommodation of persons, animals, chattels or things.

**“Building Face”**

means all of the individual wall areas of a building in one plane or elevation.

**“Building Official”**

means the persons employed or contracted by the City to administer this Bylaw, and includes Building Inspectors and Plan Checkers.

**“Building Projection”**

means any projection from a building which is not a Canopy or a Projecting Sign.

**“Bus Shelter Sign”**

means a sign on a structure intended to shelter bus patrons and situated on land which adjoins a bus stop in ordinary use by buses operated by a public transit authority.

**“Business License Officer”**

means the persons employed or contracted by the City to administer this Bylaw and the City’s “Business License” and “Ticketing for Bylaw Offenses” Bylaw.

**“Bylaw Enforcement Officer”**

means the persons employed or contracted by the City to administer this Bylaw and the City’s “Ticketing for Bylaw Offenses” Bylaw.

**“Canopy”**

means a rigid, permanent roof-like shelter or marquee extending from all or part of a building face.

**“Canopy Sign”**

means any Sign painted onto, attached to or constructed as part of or installed on the face of a Canopy and does not extend vertically or horizontally beyond the limits of the Canopy.

**“Changeable Copy Sign”**

means a Sign on which the Copy can be changed mechanically or manually through the use of detachable letters, numbers or pictorials, but does not include an Electronic Message Board Sign.

**“City”**

means the Corporation of the City of White Rock and its designated officials.

**“Clearance”**

means the vertical distance from Grade to the underside of the Sign or its supporting structure, whichever is less.

**“Community Event Sign”**

means a Temporary Sign for a special community event, charitable, civic, patriotic or religious purpose indicating that the activity is to be, or is being carried on.

**“Comprehensive Sign Plan”**

means a comprehensive plan for the signage on a site, approved through a development permit, which specifies the size, type, illumination, Height, design, location and number of Signs for the new development or the redevelopment of a site.

**“Copy”**

means the letters, characters, numbers, Logos or graphics which make up the messages on a Sign, but does not include the background colour.

**“Copy Area”**

means the area within a square, rectangle, triangle or circle, or combination of these figures, which encloses all of the Copy on the Sign.

**“Corner Lot”**

means a Lot with both Frontage and Flankage adjacent to a public street.

**“Council”**

means the municipal Council of the Corporation of the City of White Rock.

**“Courtesy Bench Sign”**

means a Sign forming part of a bench located on public property at a bus stop, rest area or park.

**“Directional Sign”**

means a Sign directing people or traffic, or indicating the direction or route from the Sign to a business or businesses, place or event.

**“Directory Sign”**

means a Sign located at the premise of a place of worship, service club or organization which contains information on the organization and its meetings and events.

**“Electronic Message Board Sign”**

means a Sign which displays illuminated and changing or moving effects, or a Sign with moving letters, symbols or changing messages.

**“Face of a Sign”**

means a side of a Sign where Copy may be placed.

**“Fascia Sign”**

means a Sign painted on, attached to or recessed into the face or wall of a Building.

**“Flankage”**

means the length of the longer of the property lines of a parcel of land abutting a public street on a corner lot, excluding a lane.

**“Flashing Sign”**

means a Sign which contains or gives the illusion of intermittent or flashing light sources but does not include an Electronic Message Board Sign or time and temperature sign.

**“Free-Standing Sign”**

means a Sign, excluding a Billboard, which is attached to the ground and is supported independently of any building or structure.

**“Free-Standing Portable Sign”**

means a Portable Sign supported by a metal or other rigid frame with a stable base.

**“Frontage”**

means the length of a property line of a parcel of land abutting a public street, excluding a lane. Where a property is on a corner Lot, the Frontage shall be deemed to be the shorter of the two property lines.

**“Grade”**

means the average ground surface elevation within 1.0 metre (3.28 feet) horizontally from the Sign.

**“Height”**

means the vertical distance measured from the Grade to the highest point of a Sign.

**“Home Occupation Sign”**

means a Sign indicating that a home occupation is carried out in the building to which the sign is affixed.

**“Identification Sign”**

means a Sign containing only the name, address and number of the Building, institution or person, or a description of an activity in the Building or institution, or the occupation of the person.

**“Illuminated Sign”**

includes a Sign which is:

- (a) internally illuminated (directly illuminated); or
- (b) which reflects light from a source intentionally directed upon it (indirectly illuminated): or
- (c) where the surface upon which individually mounted letters has light directed upon it (halo lit).

**“Life Style Graphics”**

means graphics, images, Murals and Copy which are affixed to the windows of a business.

**“Logo”**

means a symbolic representation not including words, names or numbers unless part of a registered trademark, which is used exclusively to simplify the advertising of a product, business, service or activity and which contains no additional identification, information or message.

**“Lot”**

means a separate and distinct parcel in which land is held or into which land is subdivided.

**“Menu Box”**

means a display box containing the menu or special promotions of a restaurant.

**“Monument Sign”**

means a Free-standing Sign, attached to the ground, which is supported by and integrated with a solid base.

**“Mural”**

means a graphic representation on the face of a Building or structure which is decorative and has limited identification, advertising or information purpose.

**“Political Sign”**

means a Sign erected to support the election of a particular candidate or the support for a particular cause at a municipal, provincial or federal election.

**“Portable Sign”**

means any Sign which is easily moved and which is not permanently attached to the ground or to a Building.

**“Premise”**

means that area of a Lot or Building or portion thereof occupied by a business.

**“Prohibition/Trespass Sign”**

means a Sign which provides a warning, prohibition or penalty respecting the site or Premise on which it is located.

**“Projecting Sign”**

means a Sign other than an Awning Sign, Canopy Sign or Fascia Sign which is attached to and projects from a Building face.

**“Promotional Sign”**

means a Temporary Sign advertising a promotion, new business or change in ownership of a business on the Premises to which the Sign is affixed.

**“Pylon Sign”**

means a Free-standing Sign supported by a pole or similar structure.

**“Real Estate Sign”**

means a Temporary, Free-standing or Fascia Sign indicating that the property on which the Sign is located is for sale, rent or lease.

**“Real Estate Directional Sign”**

means a Temporary Sign directing the public to a specify property which is for sale, rent or lease.

**“Roof Sign”**

means any Sign erected above the roof line, or line made by the intersection of the exterior wall of a Building with the roof of the Building.

**“Sandwich Board Sign”**

means a Portable Sign consisting of two rigid surfaces attached together at one edge.

**“Sign”**

means any visual communication device or medium which is visible from any public location including any dedicated right-of-way, which by means of Sign Copy, Illumination, inscription or other means attracts attention for advertising, identification or information purposes.

**“Sign Area”**

means the total area within the outer edge of the frame or border of a Sign, counting all Sign Faces. Where a Sign has no frame or physical or visual borders, the Sign Area is the same as the Copy Area of the Sign.

**“Temporary Sign”**

means a Sign erected for a limited period of time as authorized in this Bylaw.

**“Under Awning/Under Canopy Sign”**

means any Sign which is suspended from and is entirely beneath an Awning or Canopy.

**“Third Party Sign”**

means a Sign which directs attention to a business, commodity, service or entertainment which is conducted, sold or offered elsewhere than on the Premises on which the Sign is located.

**“Vehicle Sign”**

means a Sign attached to, painted on or mounted on a parked vehicle or trailer not normally used in the daily activity of the business, with the sign visible from a public location so as to act as a sign for the advertisement of products or to direct people to a business or activity.

4. Where a word or term is not defined in this Bylaw, it shall have the meaning assigned by the City’s Zoning Bylaw as amended.

**PART 2 – APPLICATION OF THIS BYLAW**

1. This Bylaw applies to all Signs within the municipal boundaries of the City of White Rock, with the exception of addressing information attached to a building.  
~~1. This Bylaw applies to Signs on any property within the municipal boundaries of the City of White Rock, and to all Signs encroaching on or over a street or lane.<sup>1</sup>~~
2. No sign shall be erected, placed or displayed within the City except in conformity with the provisions of this Bylaw.

---

<sup>1</sup> Amended by Bylaw No. 2072

### **PART 3 – ADMINISTRATION OF THIS BYLAW**

1. The Building Official is authorized to receive and process applications and to issue permits in accordance with the provisions of this Bylaw.
2. The Building Official shall issue a permit if the application complies with all provisions of this Bylaw.
3. No permit shall be issued for any Sign where the proposed Sign does not comply with the provisions of this Bylaw.
4. Notwithstanding the clause above, in the event that a proposed Sign does not satisfy all of the requirements set out in this Bylaw, the applicant may submit an application to vary the provisions of this Bylaw.
5. The provisions of this Bylaw may be varied in conjunction with the approval by Council of a Comprehensive Sign Plan and Development Permit.
6. A permit shall expire if active work is not commenced within a period of six months from the date of its issuance.
7. The Building Official may refuse to issue a permit where the installer does not hold a valid business licence to carry on the business of installing Signs within the City.
8. Reference in this Bylaw to any zone shall be in reference to such zones as described in the City of White Rock Zoning Bylaw as amended.

#### Application for a Sign Permit

9. Every application for a sign permit for a Sign other than a Temporary Sign shall include a completed sign application form signed by the Building or site owner or authorized agent and the person responsible for installing the Sign, containing the name and address of the Sign manufacturer, proof of professional liability insurance and the following information:
  - 9.1. The civic address and legal description of the property, Building or structure;
  - 9.2. Scaled drawings showing the location, size, dimensions, Height, Clearance, weight, materials, finishes, colours, size of lettering, Copy and graphics, method of illumination, method of construction and details of the supporting structure, and estimated cost (including installation) of all proposed Signs;
  - 9.3. A current photo of the wall surface to which the Sign is to be attached; and
  - 9.4. For Free-standing Signs, the proposed location of the Sign in relation to the property lines.

10. Every application for a sign permit for a Temporary Sign including a Sandwich Board Sign, a Free-standing Portable Sign or a Promotional Sign shall include:
  - 10.1. A completed Sign Application Form signed by site owner or authorized agent and containing the civic address and legal description of the property;
  - 10.2. A sketch or photograph of the proposed location of the Sign in relation to the building facade or property lines, building access, and if applicable, dimensions of the unimpeded sidewalk area; and
  - 10.3. A sketch or photograph of the proposed Sign.

#### Application for a Comprehensive Sign Plan

11. A Comprehensive Sign Plan shall be submitted showing the size, dimensions, Height, clearance, design concept and method of illumination of all existing and proposed Signs for any new building or major redevelopment\* of a building, group of buildings or multi-tenant complex in any CS zone, CR zone or applicable CD zone. Every application for a Comprehensive Sign Plan shall include a completed development permit application in addition to the information required by this Bylaw. (\*Major redevelopment involves 50% or more upgrade to the value of the improvement).

#### Sign Construction, Maintenance and Safety

11. The Building Official may refuse to issue a permit for a Sign where:
  - 12.1 The Building or structure to which the Sign is to be attached is incapable of supporting the Sign, or the information submitted regarding the construction of the building or structure is insufficient to allow a determination of its capability to safely support the Sign;
  - 12.2 The proposed Sign would obstruct or interfere with any traffic control device or interfere with the safety of motorists or pedestrians.
12. Where the Building Official has concerns for the structural integrity of a proposed Sign, they may require, as a condition of the issuance of any permit, that all drawings and specifications, or any part thereof, be prepared and sealed by, and the construction carried out under the supervision of a Professional Engineer registered in the Province of British Columbia. The Building Official may refuse to issue a permit until he is provided with a letter signed by such Professional Engineer, undertaking to supervise the work authorised by such permit, or any part thereof, until it is completed.

#### **PART 4 – PROHIBITED SIGNS**

1. Signs that are not expressly permitted by this Bylaw are prohibited.
2. The following types of Signs are specifically prohibited:
  - 2.1. Animated Signs
  - 2.2. Balloons or inflatable signs
  - 2.3. Billboard Signs

- 2.4. Flashing Signs
  - 2.5. Portable Signs except for Sandwich Board Signs as regulated by this Bylaw
  - 2.6. Pylon Signs
  - 2.7. Roof Signs
  - 2.8. Streamers and strings of light not continually attached to a building or landscape feature
  - 2.9. ~~Third Party Signs except for Community Event Signs, Bus Shelter Signs, Courtesy Bench Signs and Directional Signs as regulated by this Bylaw<sup>2</sup>~~
  - 2.9. Third Party signs except for Signs authorized by the City on property owned or leased by the City including for third party advertising, Community Event Signs, Bus Shelter Signs, Courtesy Bench Signs and Directional Signs as regulated under this Bylaw.<sup>3</sup>
  - 2.10. Vehicle Signs
3. Any Sign which interferes with the safe use of the street by vehicles or pedestrians, impedes traffic or interferes with the use or visibility of any traffic control device or other equipment installed by the City or by a utility company is prohibited.
  4. Any Sign which imitates or resembles an official sign or traffic control device is prohibited.
  5. Any Sign which may damage a tree is prohibited.
  6. Any Sign that obstructs any window, door opening, passageway, fire escape, walkway, road, lane, sidewalk or similar feature is prohibited.

## **PART 5 – GENERAL PROVISIONS**

### Permits Not Required

1. A sign permit is not required:
  - 1.1. For any Sign or Logo having a total Sign Area less than 0.1 square metre (1.07 square feet).
  - 1.2. For the cleaning, maintenance and repair of any Sign.
  - 1.3. For a commemorative plaque, cornerstone, or patriotic flag.
  - 1.4. For temporary seasonal decorations.

### Permits Required

2. A sign permit is required to relocate any Sign requiring a permit, or to alter or change its supporting structure, or its Sign Copy, colour, or the name of the owner or business.

---

<sup>2</sup> Removed by Bylaw 2478

<sup>3</sup> Added by Bylaw 2478

### Sign Maintenance

3. All Signs shall be maintained to be structurally sound and free from all hazards. Any Sign Area, Sign Copy and Illumination shall be maintained in a clean, operating and readable condition, and the Lot on which Sign is located shall be maintained free of weeds or debris.

### Sign Illumination

4. Permanent signs in all CR, CS and P zones, and in CD zones that permit a commercial use, may be directly or indirectly illuminated. All signs in RS and RM zones and all signs not requiring a permit shall be non-illuminated unless otherwise permitted in Part 6 of this Bylaw.
5. Illumination for any Sign shall not create a direct glare causing nuisance to adjacent properties or create a safety concern on the adjacent public rights-of-way.
6. Externally Illuminated Signs shall use a shielded light source. Signs having individual halo-lit lettering or symbols shall be mounted on a solid, opaque background. Projecting Signs shall use a low intensity of illumination.
7. All wiring and conduits for Illuminated Signs shall be placed underground or otherwise concealed.

### Colours and Coordination

8. The colours, design and placement of Signs and their supporting structure and surrounding framework shall be coordinated with both the architectural elements of the facade and with other Signs on the facade.

### Maximum Permitted Sign Area

9. The maximum permitted Sign Area of all Signs on a Lot or Premise requiring a permit shall not exceed 0.2 square metres (2.15 square feet) of Sign Area for each 0.3 metres (0.98 feet) of Lot Frontage (see Appendix II, Illustrations “1” and “2”).
10. For Buildings located on a Corner Lot, the maximum permitted Sign Area for all Signs may be increased by 0.1 square metres (1.07 square feet) of Sign Area for each 0.3 metres (0.98 feet) of Building Face located along the Flankage of the lot.

## **PART 6 – REGULATIONS FOR SIGNS NOT REQUIRING A PERMIT**

The Signs set out in Part 6 are permitted in all zones where the associated use is permitted unless otherwise specified, and are exempt from obtaining a sign permit provided they comply with the regulations of this Bylaw.

### **1. Bed and Breakfast Signs and Home Occupation Signs**

- 1.1. One sign may be erected per bed and breakfast establishment and per home occupation use, as either a Facia Sign or as a Free-Standing Sign, provided the Sign does not exceed 0.37 square metres (4.0 square feet) in Sign Area.
- 1.2. A Free-standing Bed and Breakfast Sign or Home Occupation Sign shall not exceed 0.6 metres (2.0 feet) in height, and may be indirectly illuminated.

## **2. Civic Signs**

- 1.1 A Sign may be erected by the City for any City purpose.
- 1.2 Community Event Signs and decorative Banners on or over public rights-of-way are permitted.
- 1.3 Signs required to be posted by bylaw or by government order, rule or regulation are permitted.
- 1.4 Traffic control Signs pursuant to the *Motor Vehicle Act* are permitted.

## **3. Community Event Signs**

- 3.1 One Community Event Fascia Sign, Free-Standing Sign or Banner not exceeding a total of 3.0 square metres (32.29 square feet) in Sign Area, indicating the name, place and time of a meeting, activity or event may be erected per Lot.
- 3.2 Community Event Signs shall be displayed for no more than 30 days prior to the community event and 7 days after the event.
- 3.3 Any Community Event Sign intended for location on a public right-of-way shall only be permitted subject to the written approval of the City.

## **4. Construction Project Signage<sup>4</sup> ~~Construction Project Sign~~**

- 4.1 One Temporary Sign shall be permitted on up to two frontages of a construction project site, providing a graphic rendering of the project and identifying the owner, general contractor, architects, engineers, sub-trades and others associated with the planning, design and development of the project, provided each sign does not exceed 3.0 square metres (32.29 square feet) in Sign Area.
- 4.2 Construction Project Signs shall be removed not more than 30 days after receiving an occupancy permit for the project.
- 4.3 Signage promoting an approved development project is permitted on solid hoarding/fencing surrounding the development site.<sup>5</sup>

## **5. Development Proposal Signs**

- 5.1 Development Proposal Signs shall be a minimum of 1.5 square metres (16.15 square feet) in Sign Area, and shall be posted as a Free-Standing Signs or Facia Signs, no further than 6 metres (19.69 feet) from the property lines abutting the street line. Alternatively a Development Proposal Sign may be installed at a 45 degree angle from the intersection point of two streets on a corner Lot. Where placement of the Sign is not possible on the property, the Development Proposal Sign shall be installed on the abutting road right-of-way subject to prior written approval of the City.

---

<sup>4</sup> Amended by Bylaw No. 2072

<sup>5</sup> Amended by Bylaw No. 2072

- 5.2 Development Proposal Signs shall be installed not later than 14 days following the submission of an application to the City and must be removed within 10 days following completion of the public hearing or withdrawal of the development application.

## **6. Directional Signs**

- 6.2 Directional Signs may be located on or over City rights-of-way subject to an agreement with the City as set out in Part 8 of this Bylaw.
- 6.3 Directional Signs may have up to two Sign Faces with a maximum Sign Area of 1.5 square metres (16.15 square feet) per Sign Face and may be illuminated.
- 6.4 Two or more parties may combine their messages on one Directional Sign subject to a coordinated design concept approved by the City.

## **7. Directory Signs**

- 7.1 One Directory Sign shall be permitted on the premise occupied by a place of worship, service club, community group or similar organization.
- 7.2 Directory Signs may have up to two sign faces, with a maximum Sign Area of 1.5 square metres (16.15 square feet) per Sign Face and may be illuminated.

## **8. Identifications Signs**

- 8.1 One Identification Sign, which may identify more than one institution, person, activity or occupation located at the premises, shall be permitted for each premise.
- 8.2 In all RS, RT and RM zones identification signs shall not exceed 0.3 square metres (.98 square feet) in Sign Area or 1.5 metres (4.92 feet) in Height.

## **9. Menu Boxes**

- 9.1 A Menu Box not exceeding 0.6 square metres (6.46 square feet) may be mounted on the Fascia, affixed to the Balcony of a restaurant or located within the area defined by a sidewalk cafe business licence. Menu Boxes may be illuminated.

## **10. Political Signs**

- 10.1 Political Signs shall be displayed not more than 30 days before the date of a local government, provincial or federal election or referendum, and shall be removed within 7 days following the election or referendum.
- 10.2 Political Signs shall be non-illuminated and may have up to four Sign Faces. No single Sign Face shall exceed 2.5 square metres (26.91 square feet) in Sign Area and no free-standing political sign shall exceed 2.1 metres (6.8956 feet) in height.<sup>6</sup>

### **Note:**

4 ft x 6 ft Sign – 24 sq. ft

---

<sup>6</sup> Amended by Bylaw 2380

5 ft x 5 ft Sign – 25 sq. ft  
6 ft x 6 ft does not fit criteria (oversized).<sup>7</sup>

~~10.3 Political Signs shall not be placed on a public right-of-way or on any City property (including the promenade and pier areas) with the exception that they may be placed except that Political Signs may be placed on road ends and unopened road allowances, and on a public right-of-way (boulevard area) in a front or side yard on the inside of the sidewalk, with the permission of the adjacent property owner.<sup>8</sup> <sup>9</sup> Political Signs shall not be placed:~~

- *On a public right-of-way;*
- *On any City property (including the promenade and pier areas); and*
- *On any road ends or road allowances including road ends and road allowances adjacent to public or private property*

*With the exception that they may be places on a public right-of-way (boulevard area) in a front or side yard on the inside of the sidewalk, with the permission of the adjacent property owner.*

10.4 Any Political Sign which obstructs access or visibility for traffic or is placed on public property other than provided for in this section will be removed by the City.

10.5 Any Political Sign that does not comply with this section of the bylaw (Section 10) will be removed by the City and the candidate will be contacted with a written warning via email. If political signage from the same candidate is found in the same prohibited location following 24 hours of the written warning being issued may result in a ticket and fine being issued in accordance with the City's Ticketing Bylaw.<sup>10</sup>

**Note:** the ticket charges range from \$50 to \$100 per offense.

## 11. Prohibition/Trespass Signs

11.1 Prohibition/Trespass Signs may be displayed on any premises provided the Sign does not exceed 0.2 square metres (2.15 square feet) in sign area or a height of 2 metres (6.56 feet). A Prohibition/Trespass Sign may be indirectly illuminated.

## 12. Real Estate Signs

12.1 A maximum of two Real Estate Signs may be erected on any one unit or Lot which is for sale, rent or lease. Real Estate Signs may be Fascia Signs or Free-standing Signs.

---

<sup>7</sup> Added by Bylaw 2380

<sup>8</sup> Amended by Bylaw 2380

<sup>9</sup> Removed by Bylaw 2449

<sup>10</sup> Added by Bylaw 2380

- 12.2 The maximum Sign Face for a Real Estate Sign in any RS, RT or RM zone shall be 0.7 square metres (7.53 square feet) and the Real Estate Sign shall not be illuminated. The maximum Sign Face for a real estate sign in all other zones shall not exceed 2.2 square metres, and the Sign may be indirectly illuminated.
- 12.3 Free-standing Real Estate Signs may have a maximum of two Sign Faces and shall not exceed 1.5 metres (4.92 feet) in Height.
- 12.4 Real Estate Directional Signs may have two Sign Faces and each Sign Face shall not exceed 0.2 square metres (2.15 square feet). Real Estate Directional Signs are permitted only for the duration of open house hours and shall not be placed on City rights-of-way.

### **13. Window Signs**

- 13.1 Window Signs may be painted on, etched or installed on the inside of a window in any CR or CS zone, or in any CD zone that permits a commercial use, provided the Copy Area of the Window Sign, including all Life Style Graphics does not exceed 25 percent of the total window area. In the case of window doors, the Window Sign shall not exceed 50 percent of the glass area.

## **PART 7 – REGULATIONS FOR SIGNS Requiring A PERMIT**

The following Signs are permitted in all CR zones, CS zones and CD zones where commercial uses are located, and require a Sign Permit subject to the regulations of this Bylaw.

### **1. Awning, Canopy, Under Awning and Under Canopy Signs (see Appendix III, Illustration “3”)**

- 1.1. Signs shall be painted or affixed to the flat surface of the exterior front or sides on an Awning or a Canopy, and shall not extend vertically or horizontally beyond the limits of the Awning or Canopy.
- 1.2. An Awning or Canopy Sign may be directly or indirectly illuminated.
- 1.3. The Copy Area of an Awning or Canopy Sign shall not exceed 40% of the face of the Awning or Canopy.
- 1.4. The vertical dimension of the Copy Area shall not exceed 0.61 metres (2.0 feet) in Height.
- 1.5. Where more than one business Premise occupies a Building, an Awning or Canopy Sign shall be permitted for each business Premise. Separate Awnings and Canopies on the same Building shall be of uniform Height, character and design.
- 1.6. One Under Awning or Under Canopy Sign may be attached to the apron of an Awning or Canopy per Premise, identifying only the name of the business or the service offered. Under Awning and Under Canopy Signs shall be attached perpendicular to the Building Face. The Sign Area shall not exceed 0.3 square metres (3.23 square feet), the Copy

Area shall not exceed 0.2 metres (0.66 feet) in copy height and the Sign shall have a minimum Clearance of 2.2 metres (7.22 feet) from the finished grade of the sidewalk. All Under Awning and Under Canopy Signs on the same Building shall be of a consistent Height, material, dimension, method of Illumination and design.

## **2. Changeable Copy Signs and Electronic Message Board Signs**

- 2.1 Changeable Copy or Electronic Message Board Signs shall be permitted only at theatres, community centres, recreational establishments, schools, service stations and places of worship where changes of events and/or prices necessitates changes in the message of the sign. ~~Changeable Copy or Electronic Message Board Signs shall be permitted only at theatres, community centres, recreational establishments, schools and service stations where constant changes of events and prices necessitates changes in the message of the sign.~~<sup>11</sup>
- 2.2 The changeable Copy Area shall not exceed 50% of the sign area of a Changeable Copy Sign or an Electronic Message Board Sign.
- 2.3 Changeable Copy Sign or an Electronic Message Board Signs shall only be permitted as an integral part of, and included in the display surface of a Free-Standing Sign or Fascia Sign.

## **3. Fascia Signs**

- 3.1 Fascia Signs shall be permitted on the exterior walls of a building in all CR, CS and P zones and in all CD zones that permit a commercial use, and may be directly or indirectly illuminated.
  - 3.1.1 For all Buildings constructed after the date of the adoption of this Bylaw, Fascia Signs shall be recessed into the building so that the facade sign is flush with the exterior wall of the building, except that individual channel letter, neon letter or pin-mounted letter signs may extend up to 20.5 cm (8 inches) from the building facade.
  - 3.1.2 For existing Buildings constructed prior to the adoption of this Bylaw, Facia Signs may be permitted to be attached to the face of the building provided they extend no more than 20.5 cm (8 inches) from the face of the building.
- 3.2 Where more than one Premise occupies a Building, Fascia Signs shall be permitted for each business premise in accordance with Schedule III, Illustration "1". On a Corner Lot, a Premise may have Fascia Signs on each Building Face adjacent to a public street, in accordance with Schedule III, Illustration "1". *Added by Bylaw 2579*

~~Where more than one Premise occupies a Building, one Fascia Sign shall be permitted for each business premise. On a Corner Lot a Premise may have one Fascia Sign per Building Face. Amended by Bylaw 2090 / Removed by Bylaw 2579~~

---

<sup>11</sup> Amended by Bylaw No. 2072

- 3.3 The sign Copy shall not exceed 0.61 metres (2.0 feet) in Height and shall not exceed 45% of the Sign Area. *Added by Bylaw 2579*

~~The Sign Copy Area shall not exceed 0.61 metres (2.0 feet) in Height and shall not exceed 45% of the Sign Area. *Removed by Bylaw 2579*~~

- 3.4 Where consistent with the provisions of a Comprehensive Sign Plan, the sign Copy may be placed vertically, in which case the horizontal dimension shall not exceed 0.61 metres (2.0 feet) in width. *Added by Bylaw 2579*

~~Where consistent with the provisions of a Comprehensive Sign Plan, the Sign Copy Area may be placed vertically, in which case the horizontal dimension shall not exceed 0.61 metres (2.0 feet) in width. *Removed by Bylaw 2579*~~

- 3.5 The upper limit of a Fascia Sign shall not be higher than the roof line of a building, or the uppermost portion of a Building storey used for commercial purposes where residential uses are located above. *Added by Bylaw 2579*

- 3.6 Murals are allowed on the exterior walls of buildings, as long as the sign Copy of the Mural does not exceed 5% of the area of the Mural. *Added by Bylaw 2579*

~~Murals are allowed on the exterior walls of buildings, as long as the Sign Copy Area of the Mural does not exceed 5% of the area of the Mural. *Removed by Bylaw 2579*~~

#### **4. Free-Standing Signs (see Appendix III, Illustration “4”)**

- 4.1 A maximum of one Monument Sign with a maximum on two Sign Faces shall be permitted on a lot in any CR zone or P zone, and shall be permitted in all RS and RM zones as an Identification Sign at the entrance to a residential building or complex.

- 4.2 Free-standing Signs shall be mounted on a permanent base, and the Sign and its base shall be coordinated in colour, materials and design with the overall design and landscaping on the premise.

- 4.3 Monument Signs shall not exceed a height of 2.2 metres (7.22 feet) including the supporting base or structure, and shall not exceed a total Sign Area on the two Sign Faces of 4.0 square metres (40.05 square feet) excluding its supporting base or structure.

- 4.4 Two or more businesses may combine their signage on one single Monument Sign, provided the Sign Height and Sign Area do not exceed the provisions of Part 7, section 4.3.

- 4.5 Notwithstanding 4.3 above, properties in a P zone or a CR zone with frontage on North Bluff Road, and land area in excess of 3,600 square metres, may be permitted to have a larger monument sign and, when permitted, shall not exceed a maximum height of 6.1

metres (20 feet) and a total Sign Area on the two Sign Faces of 30 square metres (323 square feet).

## **5. Projecting Signs (see Appendix III, Illustration “5”)**

- 5.1 A maximum of one Projecting Sign shall be permitted per Premise in all CR and CS zones and CD zones where commercial uses are located, except on a Corner Lot where a Premise may have one Projecting Sign per Building Face.
- 5.2 A Projecting Sign should be located at or near the centre of the length of the Building Face or in the vicinity of the doorway of the Premise.
- 5.3 A Projecting Sign shall extend no further than 1.2 metres (3.94 feet) from the supporting wall, and have a minimum Clearance of 2.2 metres (7.22 feet) from top of Grade or sidewalk. The maximum total Sign Area on the two Sign Faces shall be 0.7 square metres (7.53 square feet).
- 5.4 Where more than one Premise occupies a Building, one Projecting Sign shall be permitted for each business Premise in a Building, provided all Projecting Signs are of uniform design, size, placement, method of Illumination and Height.

## **6. Promotional Signs**

- 6.1 One Promotional sign, which may be a Banner Sign, may be displayed on a Premise for up to three (3) separate events per year with a maximum limit of twenty-eight (28) days for any one event for a combined maximum of eighty-four (84) days for all three events.
- 6.2 In addition to 6.1, special promotional permits may be obtained by the White Rock Business Improvement Association (BIA) to authorize the placement of banners signs on multiple businesses (one per premise) for a maximum of twenty-four (24) days.
- 6.3 The approval of permits for banner signs, including the special promotional permits, shall be subject to the applicants and/or the occupants of Premises entering into agreement to accept full responsibility and liability for the placement and maintenance of the banner signs, to indemnify the City, and for the provision of proof of liability insurance in the amount of \$5 million.
- 6.4 The maximum Sign Area for a Promotional or Banner Sign shall be 3.0 m<sup>2</sup> (32.29 ft<sup>2</sup>).  
<sup>12</sup>

## **7. Sandwich Board Signs and Free-Standing Portable Signs (see Appendix III, Illustrations “6” and “7”)**

- 7.1 A maximum of one Sandwich Board Sign or one Free-Standing Portable Sign may be displayed per Premise in all CR and CS zones, and in CD zones where commercial uses are located.
- 7.2 Sandwich Board Signs and Free-Standing Portable Signs shall be displayed only during the operating hours of the business.

---

<sup>12</sup> Amended by Bylaw No. 1963

- 7.3 Sandwich Board Signs and Free-Standing Portable Signs shall not be illuminated and shall not contain Third Party advertising.
- 7.4 All Sandwich Board Signs and Free-standing Portable Signs shall be located on private property on the site for which the sign is intended. Where there is insufficient room on the site, a Sandwich Board Sign or Free-Standing Portable Sign may be placed on the area defined by a Sidewalk Cafe Business Licence with the City subject to the conditions outlined in sub-section 7.7 below and subject to the provisions of Part 8 below.
- 7.5 A Sandwich Board Sign shall not exceed a Height of 1 metre (3.28 feet) and a width of 0.61 metre (2.0 feet) and shall have a maximum of two Sign Faces, with a maximum Sign Area of 0.73 square metres (7.88 square feet) on each Sign Face.
- 7.6 A Free-Standing Portable Sign shall not exceed a Height of 1.2 metres (3.94 feet) and a width of 0.61 metres (2.0 feet) and shall have a maximum of two Sign Faces, with a maximum Sign Area of 0.73 square metres (7.88 square feet) on each Sign Face.
- 7.7 All Sandwich Board Signs and Free-Standing Portable Signs shall be placed so that there is a minimum unimpeded 1.5 metres (4.92 feet) of sidewalk width for pedestrian use.
- 7.8 All Sandwich Board Signs and Free-Standing Portable Signs shall be of a weight and construction to prevent the Sign from being blown over by wind or passing traffic.

## **8. Service Station Canopy Signs**

- 8.1 A maximum of one Sign is permitted on each face of a Canopy over service station pumps, provided that the Sign shall be less than 25 percent of the length of the canopy, the vertical dimensions of the Sign shall not exceed 0.61 metres (2.0 feet) and the entire Sign Area on the Lot as set out in Part 5 of this Bylaw.

## **PART 8 – PROVISIONS FOR SIGNS ON OR OVER PUBLIC RIGHT-OF-WAY**

1. No Sign or any part of a Sign shall be displayed upon or suspended over a public street, sidewalk, walkway or any public place where public access is allowed, unless the owner of the Sign has obtained a licence to encroach and entered into an “encroachment agreement” with the City providing for such Sign. The licence shall, among other things, contain conditions that require insurance coverage and the deposit with the City and maintains in full force and effect throughout the life of the licence, a policy of insurance in a sum of at least \$5,000,000.00 indemnifying the City against all loss, cost, damage or expense incurred by the City arising from the construction, erection, maintenance and existence of the Sign.
2. In the event that the owner fails to obtain a licence under Section 1 of this Part, it shall be lawful for the City’s Business License Officer, Bylaw Enforcement Officer or Building Official to order the owner to remove the Sign from on or over the public street walkway or

- public place. If the owner fails to remove the Sign forthwith, the City may remove the Sign at the expense of the owner.
3. The following Signs may be displayed upon or suspended over on a public right-of-way without a permit, provided the owner has obtained a licence under Section 1 of this Part :
    - 3.1. Bus Shelter Signs provided that the Signs are erected at only one end of the Bus Shelter, to a maximum of two Sign Faces and a total maximum Sign Area of 5.0 square metres (53.82 square feet).
    - 3.2. Courtesy Bench Signs.
    - 3.3. Directional Signs as authorized in Part 6.
  4. Signs which are attached to and project from Buildings, and are suspended over or placed on a public right-of-way shall only be permitted subject to receiving a sign permit consistent with Part 7 of this Bylaw, and subject to a licence as set out in Section 1 of this Part. Such Signs include:
    - 4.1. Awning and Canopy Signs
    - 4.2. Under Awning and Under Canopy Sign
    - 4.3. Projecting Signs
    - 4.4. Sandwich Board Signs

## **PART 9 – ENFORCEMENT AND PENALTIES**

1. The City's Business License Officer, Bylaw Enforcement Officer or Building Official, in the administration of the Bylaw, may:
  - 1.1. Enter any premises at any reasonable hour in order to inspect any Sign installation to ascertain compliance with the provisions of this Bylaw or any plans associated with it;
  - 1.2. Order the correction of any work which is being or has been improperly done under a permit, or is done in contravention of the terms and conditions of a permit or licence granted under Part 7;
  - 1.3. Order the cessation of work that is proceeding in contravention of this Bylaw or any licence or permit issued pursuant to this Bylaw;
  - 1.4. Revoke a permit or licence where there is a violation of any term or condition of the permit or licence or a contravention of this bylaw;
  - 1.5. Order the removal by the owner of a Sign which is Abandoned, or for which there is no valid permit or licence or which does not conform to this Bylaw;
  - 1.6. Remove a Sign placed on public property without the required permit or licence; and

- 1.7. Order the painting, cleaning, repair, maintenance, alteration or removal of any Sign which has become soiled, dilapidated, abandoned, or which constitutes a hazard to the public safety or property.
- 1.8. Any person who violates any provision of this Bylaw, or omits to do or refrains from doing anything required to be done by any of the provisions of this Bylaw commits an offence, and is liable to a fine as set out in the City's "Ticketing for Bylaw Offences Bylaw". For the purposes of this Bylaw, each day that a violation of this Bylaw is caused or permitted to continue shall constitute a separate offence.

**PART 10 – ENACTMENT**

1. If any section, subsection, clause or phrase of this Bylaw is, for any reason, held to be invalid by a court of competent jurisdiction, it will be deemed to be severed and the remainder of the Bylaw will remain valid and enforceable in accordance with its terms.
2. Any Sign lawfully in existence at the time of the adoption of this Bylaw which does not conform with the provisions of this Bylaw may continue to be used, provided it is maintained in a clean and safe condition as set out in this bylaw, but shall not be reconstructed, altered, moved or replaced except in conformity with this Bylaw.
3. White Rock Sign Bylaw, 1986, No. 1042, consolidated with amendments, is hereby repealed.
4. This Bylaw shall come into force on the date of final adoption thereof.

RECEIVED FIRST READING on the	10 <sup>th</sup> day of January, 2011
RECEIVED SECOND READING on the	10 <sup>th</sup> day of January, 2011
RECEIVED THIRD READING on the	10 <sup>th</sup> day of January, 2011
FINALLY CONSIDERED AND ADOPTED on the	24 <sup>th</sup> day of January, 2011

*Original Signed by Mayor Catherine Ferguson*

---

MAYOR

*Original Signed by Tracey Arthur, City Clerk*

---

CITY CLERK

## SCHEDULE I – TABLE OF CONTENTS

<b>PART 1 – INTRODUCTORY PROVISIONS.....</b>	<b>2</b>
Title.....	2
Purpose.....	2
Definitions .....	2
<b>PART 2 – APPLICATION OF THIS BYLAW .....</b>	<b>8</b>
<b>PART 3 – ADMINISTRATION OF THIS BYLAW .....</b>	<b>9</b>
Application for a Sign Permit.....	9
Application for a Comprehensive Sign Plan .....	10
Sign Construction, Maintenance and Safety .....	10
<b>PART 4 – PROHIBITED SIGNS .....</b>	<b>10</b>
<b>PART 5 – GENERAL PROVISIONS.....</b>	<b>11</b>
Permits Not Required.....	11
Permits Required.....	11
Sign Maintenance .....	12
Sign Illumination .....	12
Colours and Coordination .....	12
Maximum Permitted Sign Area .....	12
<b>PART 6 – REGULATIONS FOR SIGNS NOT REQUIRING A PERMIT .....</b>	<b>12</b>
1. Bed and Breakfast Signs and Home Occupation Signs.....	12
2. Civic Signs.....	13
3. Community Event Signs .....	13
4. Construction Project Sign .....	13
5. Development Proposal Signs .....	13
6. Directional Signs.....	14
7. Directory Signs .....	14
8. Identifications Signs.....	14

9. Menu Boxes .....	14
10. Political Signs .....	14
11. Prohibition/Trespass Signs.....	15
12. Real Estate Signs.....	15
13. Window Signs.....	16
<b>PART 7 – REGULATIONS FOR SIGNS REQUIRING A PERMIT .....</b>	<b>16</b>
1. Awning, Canopy, Under Awning and Under Canopy Signs (see Appendix II, Illustration “3”).....	16
2. Changeable Copy Signs and Electronic Message Board Signs.....	17
3. Fascia Signs.....	17
4. Free-Standing Signs (see Appendix II, Illustration “4”) .....	18
5. Projecting Signs (see Appendix II, Illustration “5”) .....	20
6. Promotional Signs.....	20
7. Sandwich Board Signs and Free-Standing Portable Signs (see Appendix II, Illustrations “6” and “7”) .....	20
8. Service Station Canopy Signs .....	21
<b>PART 8 – PROVISIONS FOR SIGNS ON OR OVER PUBLIC RIGHT-OF-WAY .....</b>	<b>21</b>
<b>PART 9 – ENFORCEMENT AND PENALTIES .....</b>	<b>22</b>
<b>PART 10 – ENACTMENT .....</b>	<b>23</b>
<b>SCHEDULE I – TABLE OF CONTENTS .....</b>	<b>24</b>
<b>SCHEDULE II – PERMIT FEE SCHEDULE.....</b>	<b>26</b>
<b>SCHEDULE III – ILLUSTRATIONS .....</b>	<b>27</b>

## SCHEDULE II – PERMIT FEE SCHEDULE

1. ~~Any permit fee shall be paid at the time of permit application in accordance with this Bylaw.~~
2. ~~Every applicant for a permit for a Temporary Sign shall, at the time of the application, pay a fee to the City in accordance with the following scale plus applicable taxes:<sup>13</sup>~~

<del>Sandwich Board Sign or</del>	
<del>Free-Standing Portable Sign.....</del>	<del>\$ 25.00</del>
<del>Promotional Sign.....</del>	<del>\$ 25.00 per event for a</del>
	<del>maximum of 3 events</del>
	<del>(\$75.00 total)</del>
<del>Special Promotional Sign Permit (as per sub-section 6.2)</del>	<del>no fee</del>

3. ~~Every applicant for a permit for a Permanent Sign shall, at the time of application, pay a fee to the City in accordance with the following scale plus applicable taxes.~~

~~This fee shall include a non-refundable processing fee of \$50.00 which shall be credited to the application fee if the Sign Permit is approved:~~

Table Summarizing Application Fees

Application	Fee
<del>To alter or move an existing Sign</del>	<del>\$ 50.00</del>
<del>For Free-Standing Signs up to 3 square metres of Sign Area</del>	<del>\$150.00</del>
<del>For Free-Standing Signs over 3 square metres of Sign Area</del>	<del>\$250.00</del>
<del>For Fascia, Projection, Canopy and Awning Signs</del>	<del>\$150.00</del>
<del>For an Electronic Message Board Sign</del>	<del>\$250.00</del>
<del>For a Comprehensive Sign Plan</del>	<del>\$200.00</del>
<del>For each Sign for a Premise included in an approved Comprehensive Sign Plan</del>	<del>\$ 50.00<sup>14</sup></del>

<sup>13</sup> Amended by Bylaw No. 1963

<sup>14</sup> Removed by Bylaw 2452

## **SCHEDULE II – PERMIT FEE SCHEDULE**

1. Any applicable fees, as described in the City's Fees and Charges Bylaw, shall be paid at the time of permit application.<sup>15</sup>

## **SCHEDULE III – ILLUSTRATIONS**

The attached illustrations are for information and interpretation purposes only and do not form part of this Bylaw.

---

<sup>15</sup> Added by Bylaw 2452

ILLUSTRATION "1"

**PERMITTED SIGN AREA**

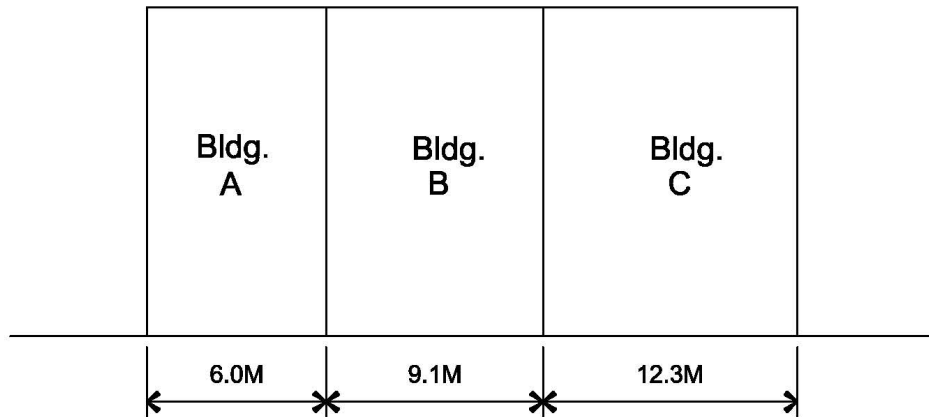

**EXAMPLES OF SIGN AREA CALCULATIONS**

BLDG.	FRONTAGE	TOTAL AREA FOR ALL SIGNS REQUIRING A PERMIT*
A	6.0M	4.0M <sup>2</sup>
B	9.1M	6.06M <sup>2</sup>
C	12.3M	8.20M <sup>2</sup>

**TOTAL AREA FOR ALL SIGNS REQUIRING A PERMIT \***  
 = 0.2M<sup>2</sup> (2.15 ft<sup>2</sup>) OF SIGN AREA PER 0.3M (0.98 ft<sup>2</sup>) OF FRONTAGE

**SAMPLE CALCULATION - BLDG. A :**  
 $6m \div 0.3 = 20 \times 0.2M^2 = 4.0M^2$

\* Includes temporary signs - ie: promotional, sandwich board and free-standing portable signs

ILLUSTRATION "2"

**SIGN AREA**

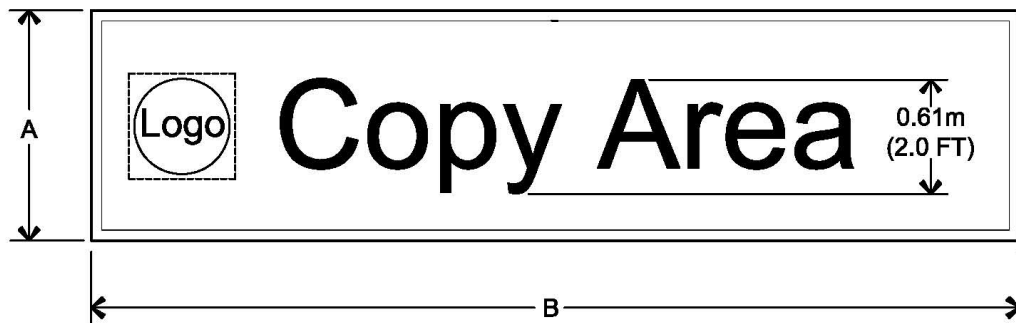

- **A X B = SIGN AREA**
- **COPY MAXIMUM VERTICAL DIMENSION**  
[0.61M (2.0 FT) WITH OR WITHOUT FRAME]

ILLUSTRATION "3"

**UNDER AWNING / CANOPY SIGN**

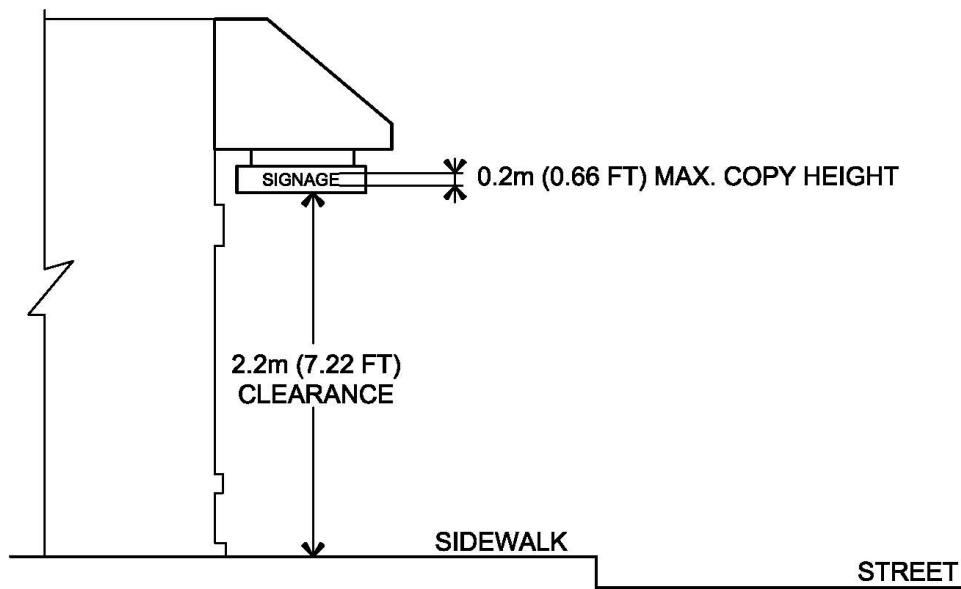

■ MAX. 0.3M<sup>2</sup> (3.23 FT<sup>2</sup>) PER SIGN FACE

ILLUSTRATION "4"

# FREESTANDING SIGNS

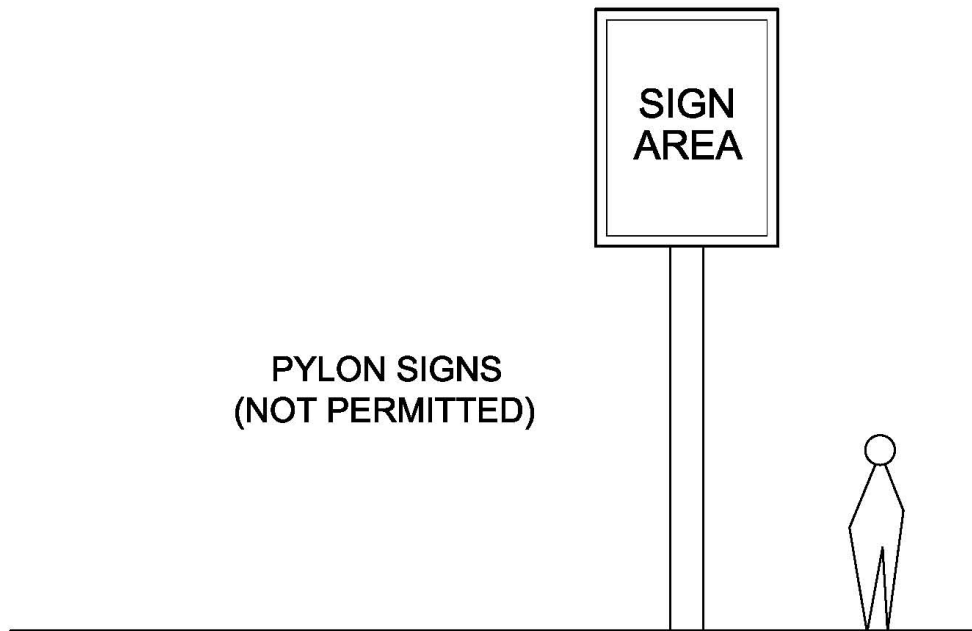
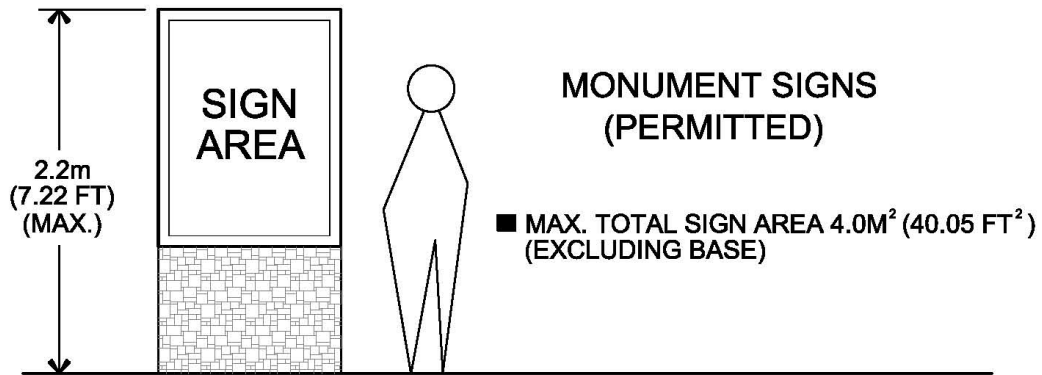
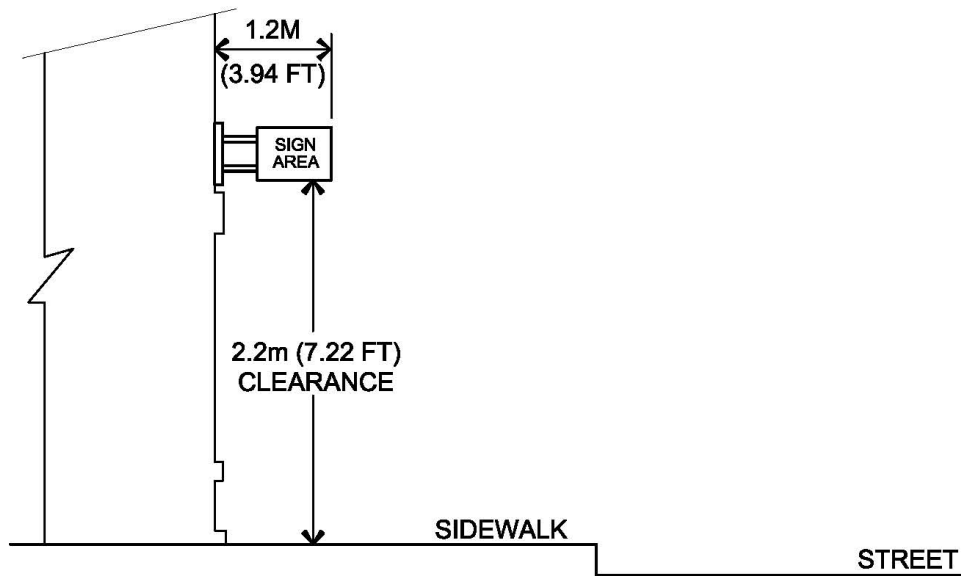

ILLUSTRATION "5"

**PROJECTING SIGN**



■ MAX. 0.35M<sup>2</sup> (3.765 FT) PER SIGN FACE

ILLUSTRATION "6"

**SANDWICH BOARD SIGN**

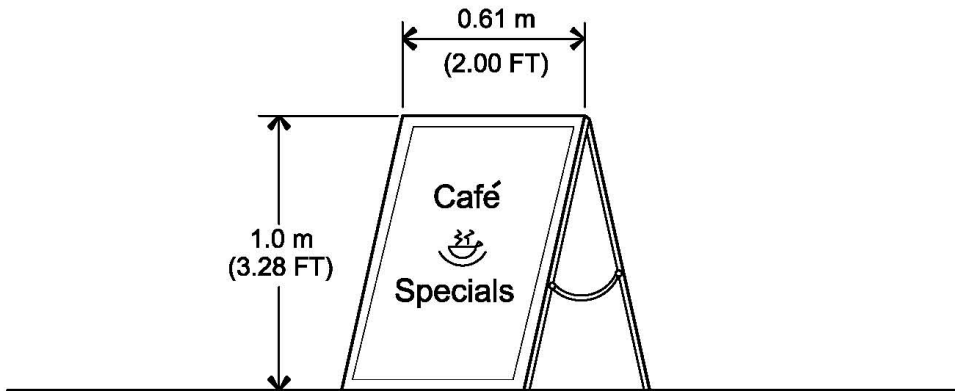

ILLUSTRATION "7"

**FREESTANDING PORTABLE SIGN**

(example)

